

Tektronix Logic Analyzer Family Product Safety & Compliance Instructions



071-2591-01

Tektronix

**Tektronix Logic Analyzer Family
Product Safety & Compliance
Instructions**

Copyright © Tektronix. All rights reserved. Licensed software products are owned by Tektronix or its subsidiaries or suppliers, and are protected by national copyright laws and international treaty provisions.

Tektronix products are covered by U.S. and foreign patents, issued and pending. Information in this publication supersedes that in all previously published material. Specifications and price change privileges reserved.

TEKTRONIX and TEK are registered trademarks of Tektronix, Inc.

Contacting Tektronix

Tektronix, Inc.
14200 SW Karl Braun Drive
P.O. Box 500
Beaverton, OR 97077
USA

For product information, sales, service, and technical support:

- In North America, call 1-800-833-9200.
- Worldwide, visit www.tektronix.com to find contacts in your area.

Table of Contents

General Safety Summary	ii
Service Safety Summary.....	iv
Compliance Information	v
EMC Compliance.....	v
Safety Compliance.....	vi
Environmental Considerations	viii
Preface	ix
Operating Requirements	1
TLA7012 Portable Mainframe Site Considerations.....	2
TLA7016 Benchtop Mainframe Site Considerations	3
Support Hardware Site Considerations	6
TLA5200B Series Logic Analyzer Site Considerations	6
TLA7000 Series Basic Installation	7
Chassis Ground Connections	7
Installing Modules in TLA7000 Series Mainframes.....	8
Connecting Accessories.....	10
TLA5200B Series Basic Installation	12
Chassis Ground Connections	12
Connecting Accessories.....	12
First Time Operation	14

General Safety Summary

Review the following safety precautions to avoid injury and prevent damage to this product or any products connected to it.

To avoid potential hazards, use this product only as specified.

Only qualified personnel should perform service procedures.

While using this product, you may need to access other parts of a larger system. Read the safety sections of the other component manuals for warnings and cautions related to operating the system.

To Avoid Fire or Personal Injury

Use Proper Power Cord. Use only the power cord specified for this product and certified for the country of use.

Use Proper Voltage Setting. Before applying power, ensure that the line selector is in the proper position for the source being used.

Connect and Disconnect Properly. Do not connect or disconnect probes or test leads while they are connected to a voltage source.

Ground the Product. This product is grounded through the grounding conductor of the power cord. To avoid electric shock, the grounding conductor must be connected to earth ground. Before making connections to the input or output terminals of the product, ensure that the product is properly grounded.

Observe All Terminal Ratings. To avoid fire or shock hazard, observe all ratings and markings on the product. Consult the product manual for further ratings information before making connections to the product.

The inputs are not rated for connection to mains or Category II, III, or IV circuits.

Connect the probe reference lead to earth ground only.

Power Disconnect. The power cord disconnects the product from the power source. Do not block the power cord; it must remain accessible to the user at all times.

Do Not Operate Without Covers. Do not operate this product with covers or panels removed.

Do Not Operate With Suspected Failures. If you suspect that there is damage to this product, have it inspected by qualified service personnel.

Avoid Exposed Circuitry. Do not touch exposed connections and components when power is present.

Replace Batteries Properly. Replace batteries only with the specified type and rating.

Use Proper AC Adapter. Use only the AC adapter specified for this product.

Use Proper Fuse. Use only the fuse type and rating specified for this product.

Do Not Operate in Wet/Damp Conditions.

Do Not Operate in an Explosive Atmosphere.

Keep Product Surfaces Clean and Dry.

Provide Proper Ventilation. Refer to the manual’s installation instructions for details on installing the product so it has proper ventilation.

Terms in this Manual These terms may appear in this manual:



WARNING. *Warning statements identify conditions or practices that could result in injury or loss of life.*



CAUTION. *Caution statements identify conditions or practices that could result in damage to this product or other property.*

Symbols and Terms on the Product

These terms may appear on the product:

- DANGER indicates an injury hazard immediately accessible as you read the marking.
- WARNING indicates an injury hazard not immediately accessible as you read the marking.
- CAUTION indicates a hazard to property including the product.

The following symbol(s) may appear on the product:



CAUTION
Refer to Manual



WARNING
High Voltage



Protective Ground
(Earth) Terminal



Earth Terminal



Chassis Ground



Mains Disconnected
OFF (Power)



Mains Connected
ON (Power)



Standby

Service Safety Summary

Only qualified personnel should perform service procedures. Read this *Service Safety Summary* and the *General Safety Summary* before performing any service procedures.

Do Not Service Alone. Do not perform internal service or adjustments of this product unless another person capable of rendering first aid and resuscitation is present.

Disconnect Power. To avoid electric shock, switch off the instrument power, then disconnect the power cord from the mains power.

Use Care When Servicing With Power On. Dangerous voltages or currents may exist in this product. Disconnect power, remove battery (if applicable), and disconnect test leads before removing protective panels, soldering, or replacing components.

To avoid electric shock, do not touch exposed connections.

Compliance Information

This section lists the EMC (electromagnetic compliance), safety, and environmental standards with which the instrument complies.

EMC Compliance

EC Declaration of Conformity – EMC

Meets intent of Directive 2004/108/EC for Electromagnetic Compatibility. Compliance was demonstrated to the following specifications as listed in the Official Journal of the European Communities:

EN 61326-1:2006, EN 61326-2-1:2006. EMC requirements for electrical equipment for measurement, control, and laboratory use.^{1 2}

- CISPR 11:2003. Radiated and conducted emissions, Group A
- IEC 61000-4-2:2001. Electrostatic discharge immunity
- IEC 61000-4-3:2002. RF electromagnetic field immunity
- IEC 61000-4-4:2004. Electrical fast transient/burst immunity
- IEC 61000-4-5:2001. Power line surge immunity
- IEC 61000-4-6:2003. Conducted RF immunity
- IEC 61000-4-11:2004. Voltage dips and interruptions immunity³

EN 61000-3-2:2006. AC power line harmonic emissions

EN 61000-3-3:1995. Voltage changes, fluctuations, and flicker

European Contact.

Tektronix UK, Ltd.
Western Peninsula
Western Road
Bracknell, RG12 1RF
United Kingdom

¹ This product is intended for use in nonresidential areas only. Use in residential areas may cause electromagnetic interference.

² Emissions which exceed the levels required by this standard may occur when this equipment is connected to a test object.

³ Performance Criterion C applied at the 70%/25 cycle Voltage-Dip and the 0%/250 cycle Voltage-Interruption test levels (IEC 61000-4-11).

**Australia / New Zealand
Declaration of
Conformity – EMC**

Complies with the EMC provision of the Radiocommunications Act per the following standard, in accordance with ACMA:

- CISPR 11:2003. Radiated and Conducted Emissions, Group 1, Class A, in accordance with EN 61326-1:2006 and EN 61326-2-1:2006.

Safety Compliance

**EC Declaration of
Conformity – Low Voltage**

Compliance was demonstrated to the following specification as listed in the Official Journal of the European Communities:

Low Voltage Directive 2006/95/EC.

- EN 61010-1: 2001. Safety requirements for electrical equipment for measurement control and laboratory use.

**U.S. Nationally Recognized
Testing Laboratory Listing**

- UL 61010-1:2004, 2nd Edition. Standard for electrical measuring and test equipment. ¹

¹ TLA7016 Benchtop Mainframes and TLA5200B Series Logic Analyzers comply with UL61010B-1:2003, 1st edition, Standard for electrical measuring and test equipment.

Canadian Certification

- CAN/CSA-C22.2 No. 61010-1:2004. Safety requirements for electrical equipment for measurement, control, and laboratory use. Part 1. ¹

¹ TLA7016 Benchtop Mainframes and TLA5200B Series Logic Analyzers comply with CAN/CSA C22.2 No. 61010.1-97, 1st edition, Second Amendment. Safety requirements for measurement, control, and laboratory use. Part 1.

Additional Compliances

- IEC 61010-1: 2001. Safety requirements for electrical equipment for measurement, control, and laboratory use.

Equipment Type

Test and measuring equipment.

Safety Class

Class 1 – grounded product.

**Safety Certification of
Plug-in or VXI Modules**

The safety certification is valid only when installed in an appropriately approved (by a USA NRTL or a Canada Certified Organization) mainframe.

Pollution Degree Description	<p>A measure of the contaminants that could occur in the environment around and within a product. Typically the internal environment inside a product is considered to be the same as the external. Products should be used only in the environment for which they are rated.</p> <ul style="list-style-type: none"> ■ Pollution Degree 1. No pollution or only dry, nonconductive pollution occurs. Products in this category are generally encapsulated, hermetically sealed, or located in clean rooms. ■ Pollution Degree 2. Normally only dry, nonconductive pollution occurs. Occasionally a temporary conductivity that is caused by condensation must be expected. This location is a typical office/home environment. Temporary condensation occurs only when the product is out of service. ■ Pollution Degree 3. Conductive pollution, or dry, nonconductive pollution that becomes conductive due to condensation. These are sheltered locations where neither temperature nor humidity is controlled. The area is protected from direct sunshine, rain, or direct wind. ■ Pollution Degree 4. Pollution that generates persistent conductivity through conductive dust, rain, or snow. Typical outdoor locations.
Pollution Degree	Pollution Degree 2 (as defined in IEC 61010-1). Note: Rated for indoor use only.
Installation (Overvoltage) Category Descriptions	<p>Terminals on this product may have different installation (overvoltage) category designations. The installation categories are:</p> <ul style="list-style-type: none"> ■ Measurement Category IV. For measurements performed at the source of low-voltage installation. ■ Measurement Category III. For measurements performed in the building installation. ■ Measurement Category II. For measurements performed on circuits directly connected to the low-voltage installation. ■ Measurement Category I. For measurements performed on circuits not directly connected to MAINS.
Overvoltage Category	Overvoltage Category II (as defined in IEC 61010-1)

Environmental Considerations

This section provides information about the environmental impact of the product.

Product End-of-Life Handling

Observe the following guidelines when recycling an instrument or component:

Equipment Recycling. Production of this equipment required the extraction and use of natural resources. The equipment may contain substances that could be harmful to the environment or human health if improperly handled at the product's end of life. In order to avoid release of such substances into the environment and to reduce the use of natural resources, we encourage you to recycle this product in an appropriate system that will ensure that most of the materials are reused or recycled appropriately.



This symbol indicates that this product complies with the applicable European Union requirements according to Directives 2002/96/EC and 2006/66/EC on waste electrical and electronic equipment (WEEE) and batteries. For information about recycling options, check the Support/Service section of the Tektronix Web site (www.tektronix.com).

Mercury Notification. This product uses an LCD backlight lamp that contains mercury. Disposal may be regulated due to environmental considerations. Please contact your local authorities or, within the United States, refer to the E-cycling Central Web page (www.eiae.org) for disposal or recycling information.

Perchlorate Materials. This product contains one or more type CR lithium batteries. According to the state of California, CR lithium batteries are classified as perchlorate materials and require special handling. See www.dtsc.ca.gov/hazardouswaste/perchlorate for additional information.

Restriction of Hazardous Substances

This product has been classified as Monitoring and Control equipment, and is outside the scope of the 2002/95/EC RoHS Directive.







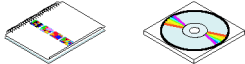

Preface

This document contains safety, environmental, and compliance information for your Tektronix TLA7000 Series and TLA5200 Series Logic Analyzer products.

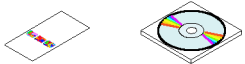
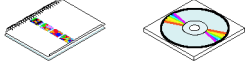
To prevent personal injury or damage, consider the following requirements before starting service:

- The procedures in this manual should be performed only by qualified service personnel.
- Read the General Safety Summary and Service Safety Summary found at the beginning of this manual.
- For detailed installation information, refer to the *TLA7000 Series Logic Analyzer Installation Manual* or to the *TLA5000B Series Logic Analyzer Installation Manual* available on the TLA Documentation CD or on the Tektronix Web site (www.tektronix.com/manuals).

Related Documentation

Item	Purpose	Location
TLA Quick Start User Manuals	High-level operational overview	
Online Help	In-depth operation and UI help	
Installation Quick Reference Cards	High-level installation information	
Installation Manuals	Detailed first-time installation information	
XYZs of Logic Analyzers	Logic analyzer basics	 www.Tektronix.com
Declassification and Security instructions	Data security concerns specific to sanitizing or removing memory devices from Tektronix products	 www.Tektronix.com
Application notes	Collection of logic analyzer application specific notes	
Product Specifications & Performance Verification Procedures	TLA Product specifications and performance verification procedures	
TPI.NET Documentation	Detailed information for controlling the logic analyzer using .NET	

Related Documentation (cont.)

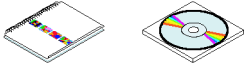
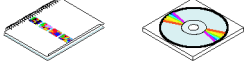
Item	Purpose	Location
Field upgrade kits	Upgrade information for your logic analyzer	
Optional Service Manuals	Self-service documentation for modules and mainframes	

Operating Requirements

Read this section before installing the instrument. This section describes environmental and power requirements for your logic analyzer product.

Verify that you have received all of the parts of your instrument and for the following:

- Correct power cords for your geographical area
- Correct probes and modules
- Standard accessories
- All optional accessories that you ordered

TLA7000 Series Logic Analyzer Environmental Requirements

The following table describes the environmental requirements for the TLA7000 Series Logic Analyzer.



CAUTION. For the TLA7012 Portable Mainframe, allow a 15.3 cm (6-in) clearance at the top, back, and sides of the instrument to ensure proper cooling. Keep the bottom of the instrument clear.

For the TLA7016 Benchtop Mainframe and the TLA7PCI Benchtop Controller PC, allow a 5.1 cm (2-in) clearance at the top, back, and sides of the instrument to ensure proper cooling.

For the TL708EX TekLink 8-Port Hub allow a 15.3 cm (6-in) clearance at the back of the instrument to ensure proper cooling.

Inadequate clearances can cause the instrument to overheat and shut down.

Table 1: TLA7000 Series Logic Analyzer environmental requirements

Feature		Description
Temperature	Operating	+5 °C to +45 °C ¹
	Nonoperating	-20 °C to +60 °C
Humidity 20% to 80%	Operating	≤30 °C; 80% relative humidity (29 °C maximum wet bulb temperature) ²
	Nonoperating	8% to 80% (29 °C maximum wet bulb temperature)
Altitude	Operating and nonoperating	To 3000 m (9843 ft.)

¹ The operating temperature for the TL708EX TekLink 8-Port Hub is 0 °C to +50 °C

² The operating humidity for the TL708EX TekLink 8-Port Hub is 5% to 95% relative humidity at an altitude up to 3000 m (9843 ft.)

TLA5200B Series Logic Analyzer Environmental Requirements

The following table describes the environmental requirements for the TLA5200B Series Logic Analyzer.



CAUTION. Allow a 5.1 cm (2 in) clearance around the top, back, and sides of the instrument to ensure proper cooling. Inadequate clearances can cause the instrument to overheat and shut down.

Table 2: TLA5200B Series Logic Analyzer environmental requirements

Feature	Description	
Temperature	Operating	+5 °C to +50 °C
	Nonoperating	–20 °C to +60 °C
Humidity 20% to 80%	Operating	20% to 80% relative humidity, noncondensing (29 °C maximum wet bulb temperature)
	Nonoperating	8% to 80% (29 °C maximum wet bulb temperature)
Altitude	Operating	To 3000 m (9843 ft.)
	Nonoperating	12,190 m (40,000 ft)

TLA7012 Portable Mainframe Site Considerations

You can use the portable mainframe on a bench or on a cart in the normal position (on the bottom feet). The front feet extend to give a better view of the instrument display. You can also mount the mainframe in an instrument rack.

Table 3: TLA7012 Portable Mainframe power requirements

Feature	Description
Voltage range and frequency	100 V _{RMS} to 240 V _{RMS} ±10%, 50 Hz to 60 Hz
	115 V _{RMS} ±10%, 400 Hz
Input current	6 A _{RMS} maximum at 90 V _{RMS} , 60 Hz or 100 _{RMS} , 400 Hz (70 A surge)
Power consumption	750 W maximum

TLA7016 Benchtop Mainframe Site Considerations

The TLA7016 Benchtop Mainframe is designed to operate on a bench, on a cart, or in a rackmount environment. If you need to stack more than two benchtop mainframes, install the mainframes in a rack.



WARNING. *To avoid personal injury, never lift or move a benchtop mainframe by yourself. The size and weight of the mainframe requires two people to lift or move it.*

Do not stack more than one benchtop mainframe on top of another benchtop mainframe. Always use a rackmount kit to ensure that the mainframes are secure and will not fall.

NOTE. *The ratings in the following table are nominal line voltages and power going into the power supply.*

Table 4: TLA7016 Benchtop mainframe power requirements

Feature	Description
Voltage range and frequency	100 V _{RMS} to 120 V _{RMS} , 50 Hz to 60 Hz, 1450 W maximum
	120 V _{RMS} to 240 V _{RMS} , 50 Hz to 60 Hz, 1900 W maximum
	115 _{RMS} , 400 Hz
Input current	16.5 A maximum at 90 VAC (70 A surge)
Power consumption	1450 W maximum



CAUTION. *By placing too many modules in a TLA7016 Benchtop Mainframe, you can overload the power distribution system and damage the mainframe or modules. To avoid this, ensure that your module configuration in a single mainframe does not exceed 1000 W at line voltages less than 120 V nominal at 50 Hz or 60 Hz or at line voltages of 115 V at 400 Hz. Use the following table and illustration to calculate the total power for your mainframe.*

The power consumption depends on the number and type of modules installed in the mainframes. To determine the total power consumption, perform the following steps:

NOTE. *The following calculations are based on the power from the power supply, module power consumption, and worse case line voltages (nominal minus 10% low-line).*

1. Use the following table to determine the power consumption for each module.
2. Add the power for each module to determine the total power consumption (include 170 W for each benchtop mainframe).
3. Ensure that the total power consumption is less than the limits shown in the following table and illustration. (See Figure 1 on page 5.)

Table 5: Power for instrument modules

Module type	Power (Watts)
One benchtop mainframe ¹	170
TLA7AA1	45
TLA7AA2, TLA7AB2 TLA7AC2	65
TLA7AA3, TLA7AC3	85
TLA7AA4, TLA7AB4, TLA7AC4	105
TLA7BB2	81
TLA7BB3	119
TLA7BB4, TLA7BC4	158
TLA7NA1	45
TLA7NA2	58
TLA7NA3	71
TLA7NA4	82
TLA7Q2	51
TLA7Q4	75
TLA7P2	50
TLA7P4	74
TLA7N1	45
TLA7N2	58
TLA7N3	71
TLA7N4	82
TLA7L1	55
TLA7L2	73
TLA7L3	94
TLA7L4	109
TLA7M1	57
TLA7M2	76
TLA7M3	99
TLA7M4	116
TLA7D1	80
TLA7D2	111
TLA7E1	90

Table 5: Power for instrument modules (cont.)

Module type	Power (Watts)
TLA7E2	121
TLA7PG2	110
TLA7S08	65
TLA7S16	105

¹ Power for mainframe and controller module with fans operating at maximum speed.

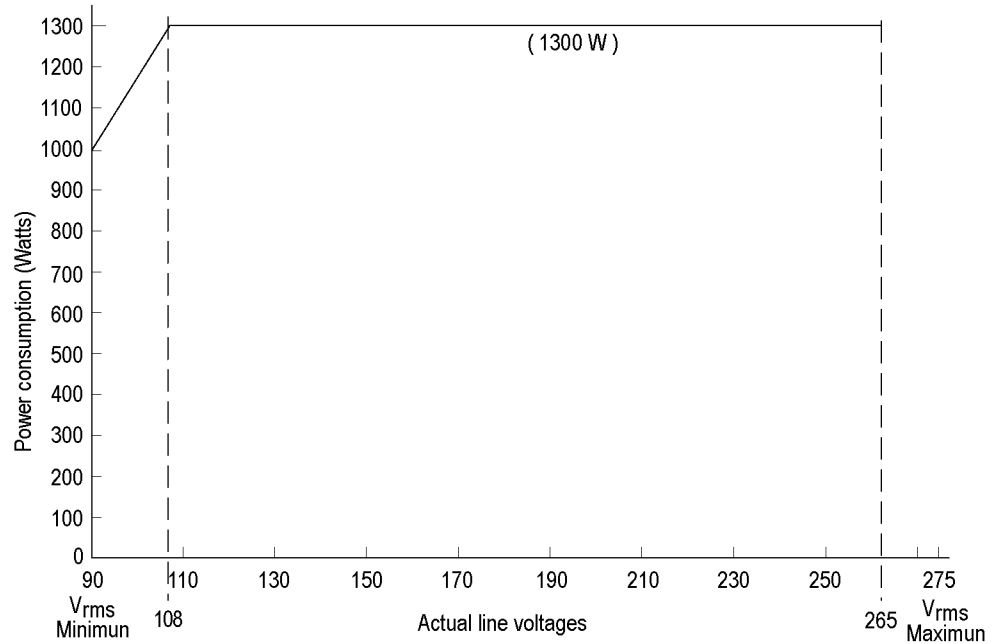

17-47-671

Figure 1: Maximum power allowed to modules at various line voltages for TLA7016 mainframes serial number B020000 and higher

Support Hardware Site Considerations

The TLA7PC1 Benchtop PC Controller, TL708EX Hub, and GbE switch units can operate separately on your workbench, equipment rack, or cart. You can also mount them to your benchtop mainframe using the brackets provided with the benchtop mainframe.

Table 6: TLA7PC1 Benchtop PC Controller power requirements

Feature	Description
Voltage range and frequency	100 V _{RMS} to 240 V _{RMS} ±10%, 50 Hz to 60 Hz
Input current	8 A _{RMS} maximum at 100 V _{RMS} , 5 A _{RMS} maximum, at 240 V _{RMS}
Power consumption	350 W maximum

Table 7: TL708EX Hub power requirements

Feature	Description
Voltage range and frequency	100 V _{RMS} to 240 V _{RMS} ±10%, 47 Hz to 63 Hz
Input current	0.9 A _{RMS} maximum at 120 V _{RMS} at 80 W
Power consumption	110 W maximum

TLA5200B Series Logic Analyzer Site Considerations

You can use the TLA5200B Series Logic Analyzer on a bench or on a cart in the normal position (on the bottom feet). You can also mount the mainframe in an instrument rack.

Table 8: TLA5200B Series Logic Analyzer Power requirements

Feature	Description
Voltage range and frequency	100 V _{RMS} to 240 V _{RMS} ±10%, 47 Hz to 63 Hz
Maximum power consumption	220 Watts line power maximum
Steady-State input current	4 A _{RMS} maximum

TLA7000 Series Basic Installation

The TLA7000 Series products are normally used in a network environment and the installation instructions for instruments in a network environment are beyond the scope of this document.

For detailed network installation information, refer to the *TLA7000 Series Logic Analyzer Installation Manual* available on the TLA Documentation CD or on the Tektronix Web site (www.tektronix.com/manuals).

Chassis Ground Connections

Use the chassis ground connections to connect the grounds of the target system to the logic analyzer to ensure a common ground connection between instruments. (See Figure 2 on page 7.)



CAUTION. To reduce the risk of ground-loop noise, ground all of the instruments in the system to the logic analyzer mainframe using the ground connections shown.

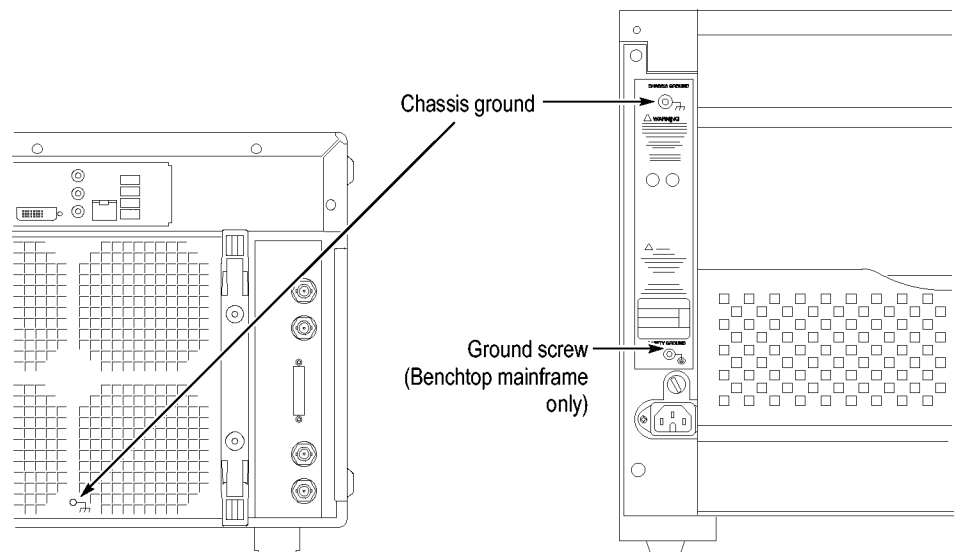

Figure 2: Location of the ground connection on the TLA7000 logic analyzers

Installing Modules in TLA7000 Series Mainframes

TLA700 Modules or TLA7000 Modules are fully compatible with the TLA7000 Series mainframes.



CAUTION. To avoid damaging the instrument, do not install or remove any modules while the instrument is powered on. Always power down the instrument before installing or removing modules.

You can merge modules together to create wider modules. If your application requires you to merge modules, do so before installing the modules in the mainframe.

Use a screwdriver to tighten the retaining screws to 2.5 in-lbs after seating the modules in place. (See Figure 3 on page 8.)

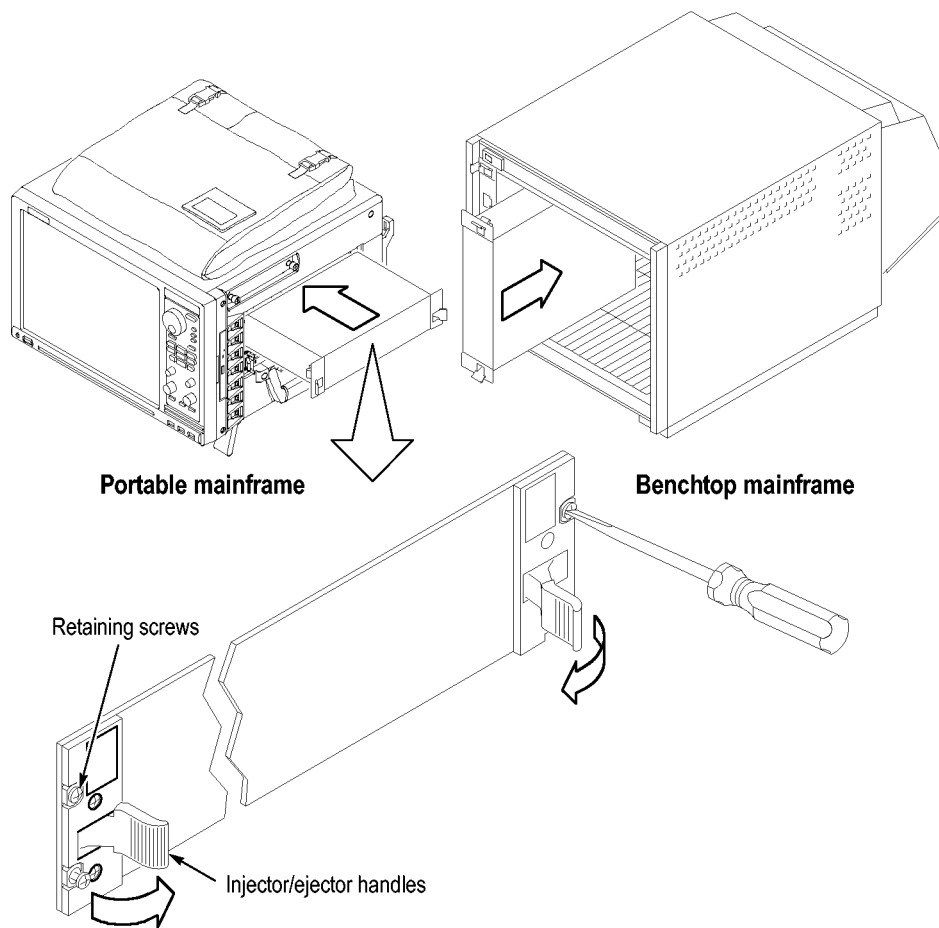

Figure 3: Installing modules

If you have any unused (empty) slots in your mainframe, install blank-slot panel covers to meet EMC and cooling specifications. Install a blank-slot panel cover for the empty slot in the portable mainframe. (See Figure 4.) Install the blank slot-panels on the benchtop mainframe. (See Figure 5.) Install the blank-slot panel covers before you install any modules. Use only Tektronix TLA covers; otherwise the mainframe may not meet EMC and cooling requirements.

Make sure that the EMI shielding is in contact with the adjacent panel or module cover, and that the airflow shutter activation arms protrude through the holes in the blank-slot panel.

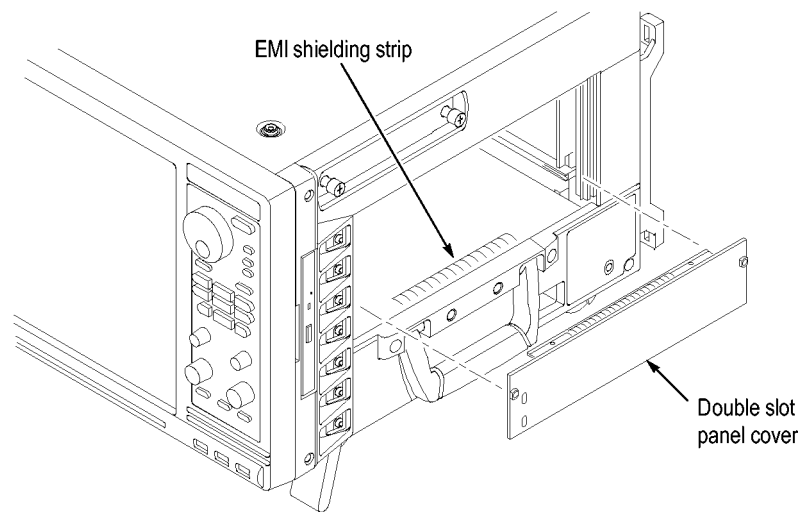

Figure 4: Installing panel covers on the portable mainframe

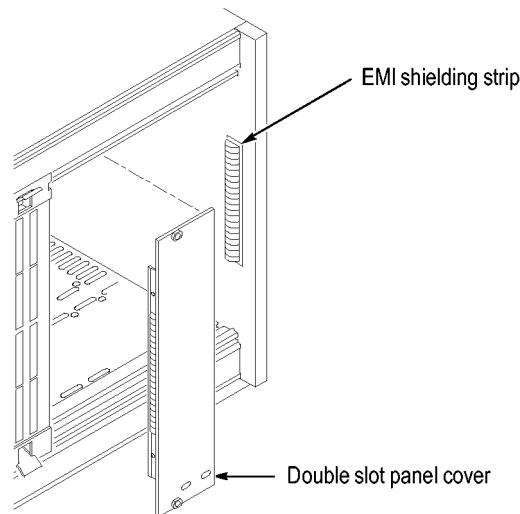

Figure 5: Installing panel covers on the benchtop mainframe

Connecting Accessories

After installing the mainframes and modules, you can connect the accessories such as external monitors, keyboard, and printer.

Connect the accessories to the TLA7012 Portable Mainframe. (See Figure 6.)
 If you have a TLA7016 Benchtop Mainframe, connect the accessories to the external PC; connect other cables and connectors to the mainframe. (See Figure 7 on page 11.)

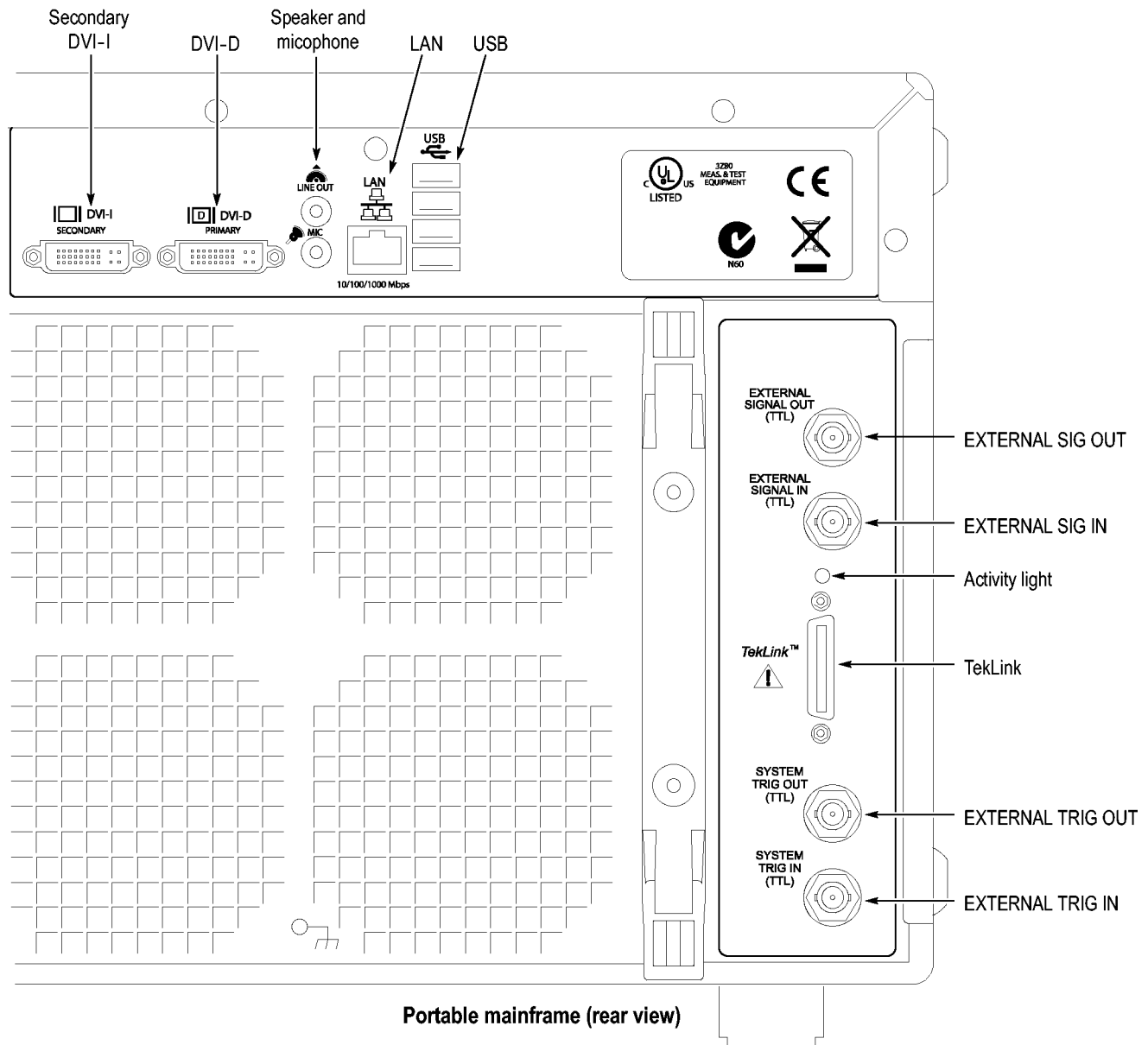

Figure 6: TLA7012 accessories connections

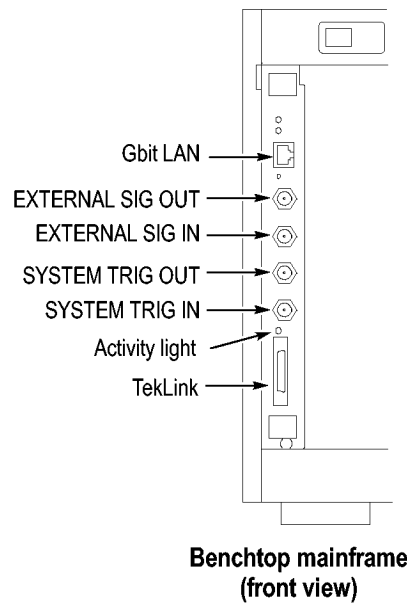

Figure 7: TLA7016 accessories connections

Connect additional accessories as needed. (See Table 9.)

Table 9: Additional accessory connection information

Item	Description
Monitor	<p>There are two display ports on the TLA7012: Primary (DVI-D, digital output only), and Secondary (DVI-I, digital/analog out). Simulscan mode displays the same information on the internal display and the external monitor connected to either Primary or Secondary.</p> <p>To change the display settings, right-click the mouse on the desktop, select Properties, and go to the Settings tab. Select the settings for your monitor. Note that some of the display settings may not function until you connect an external monitor.</p> <p>Use the VGA-to-DVI display adapter to connect a VGA monitor to the Secondary DVI-D output. If you use a nonstandard monitor, you may need to change the Windows display settings to achieve the proper resolution.</p>
LAN	<p>Connect the mainframes to your network through the Gbit LAN connectors. You can remotely control the mainframes through a LAN switch using your PC (loaded with the TLA application software), or the dedicated PC controller (TLA7PC1).</p>
Printer	<p>The instruments send printer information to the USB ports. Use any of the four USB ports for your printer.</p>

TLA5200B Series Basic Installation

For detailed installation information, refer to the *TLA5000B Series Logic Analyzer Installation Manual* available on the TLA Documentation CD or on the Tektronix Web site (www.tektronix.com/manuals).

Chassis Ground Connections

Use the chassis ground connections to connect the grounds of the target system to the logic analyzer to ensure a common ground connection between instruments. (See Figure 8.)

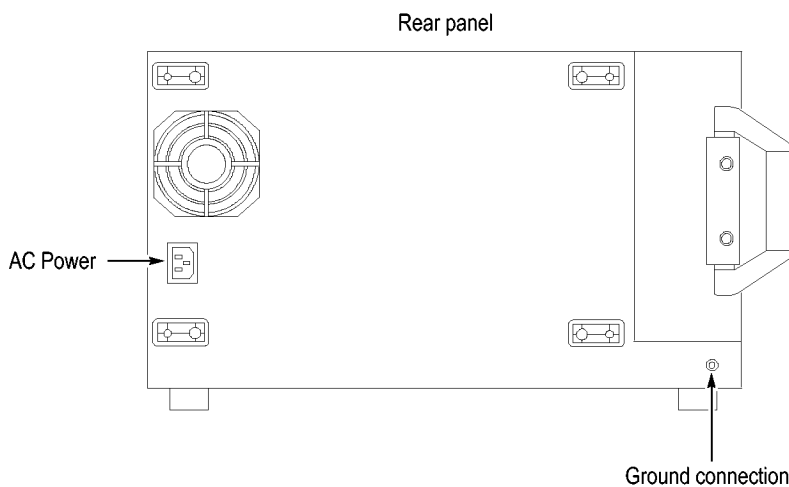

Figure 8: Location of the ground connection on the TLA5200B logic analyzers

Connecting Accessories

Connect the accessories to the side of the instrument; depending on your model, the number of connectors and locations may differ. (See Figure 9.)

Table 10: Accessory connection information

Item	Description
Monitor	If you use a non-plug & play monitor, you may need to change the Windows display settings to achieve the proper resolution.
Printer	Connect the printer to the LPT (parallel) port.
Rackmount	The logic analyzer can be installed in rackmount kits. Refer to the respective rackmount kit instructions for installation information.

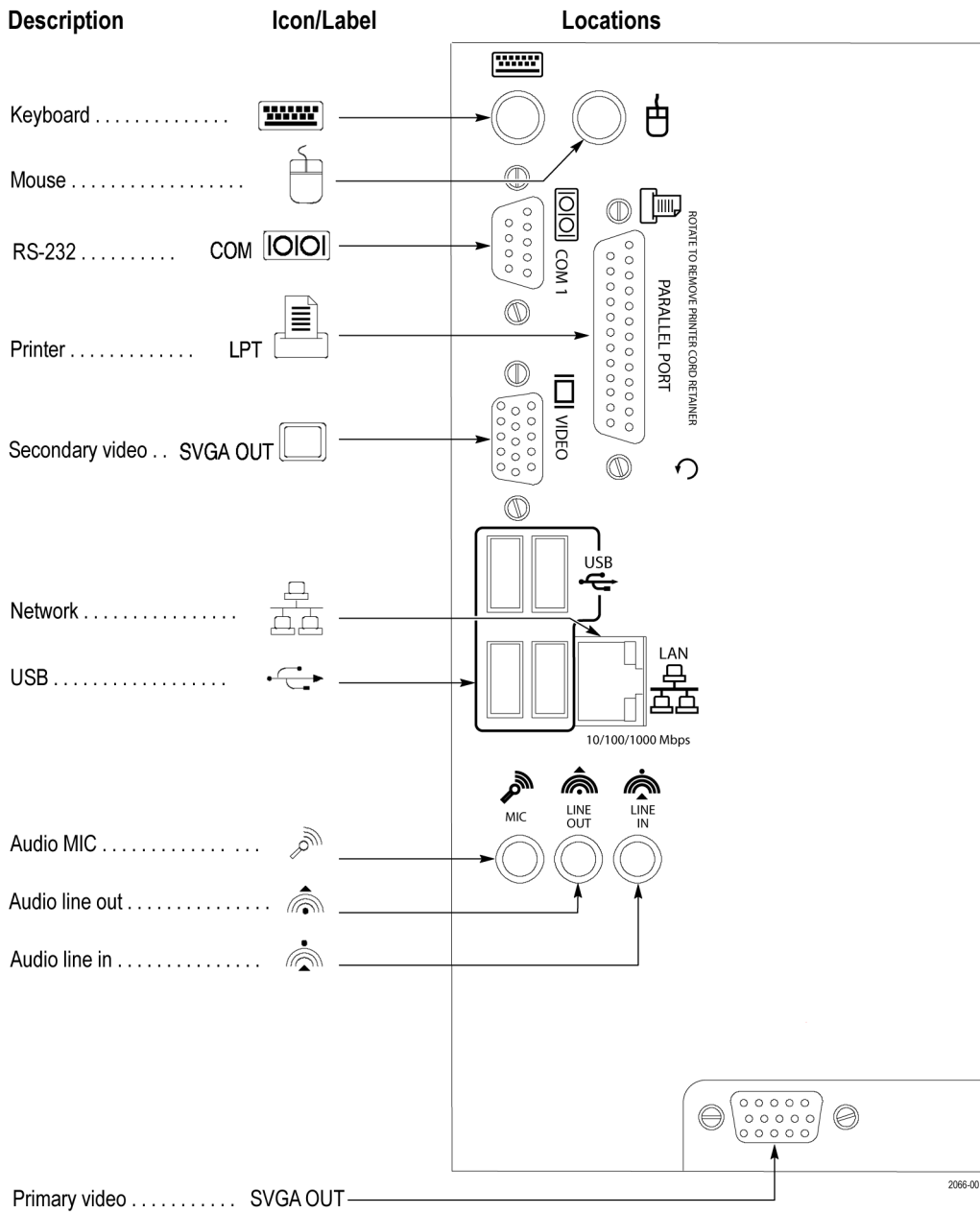

Figure 9: TLA5200B accessory connections

First Time Operation

Make sure that you connect the keyboard, mouse, and other accessories before applying power to the logic analyzer. Complete the following steps to turn on the logic analyzer for the first time:

1. Connect the power cord to your instrument.
2. If you have an external monitor, connect the power cord and turn on the monitor.

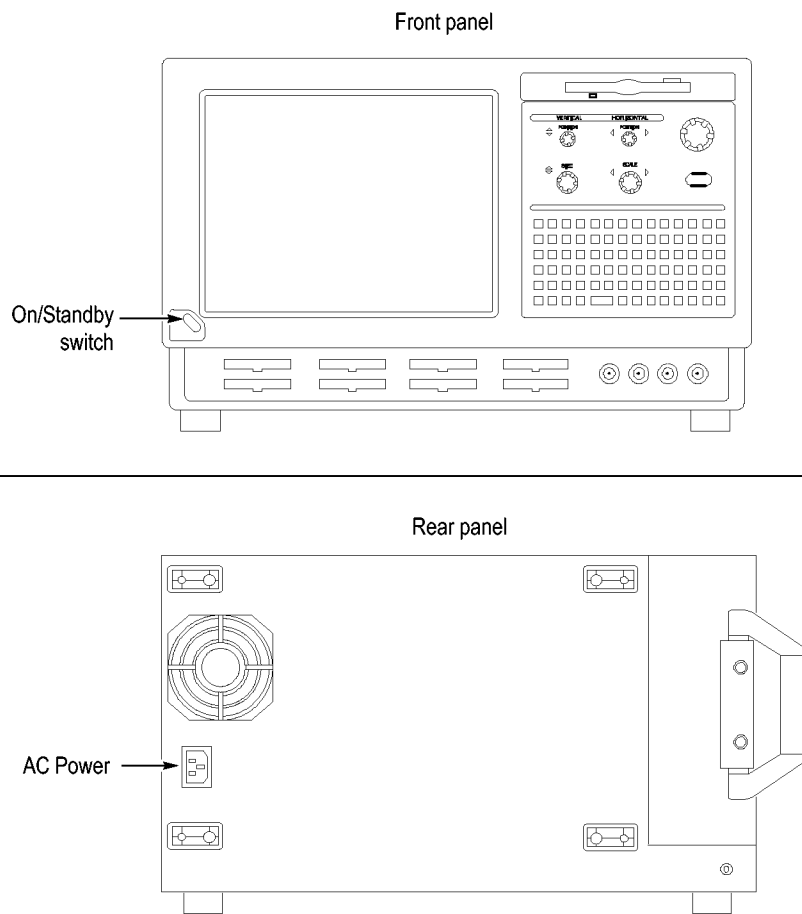

Figure 10: TLA5200B On/Standby switch location

3. Turn on the logic analyzer as follows:
 - a. Press the On/Standby switch on the front of the instrument to turn on the logic analyzer.
 - b. Wait for the logic analyzer to complete power-on self-tests and start Windows.

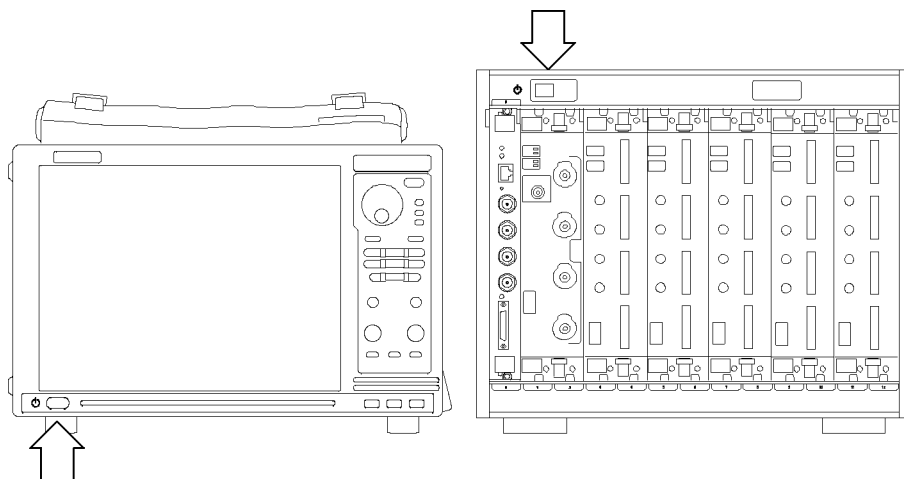

Figure 11: TLA7000 On/Standby switch locations



WARNING. *To avoid personal injury, do not remove any modules from the instrument or open the instrument to perform any internal cleaning procedures that could allow moisture to enter while the power cord is connected. Always remove the power cord to disconnect the instrument from the mains supply before opening the instrument.*

To power off the logic analyzer, press the On/Standby switch. The logic analyzers have a built-in soft power-off function that safely powers off the instruments when you press the On/Standby switch. Expansion mainframes automatically power off when you turn off the benchtop or portable mainframe.